

# LOGSTOR HEC

## Installation Instructions - Industry

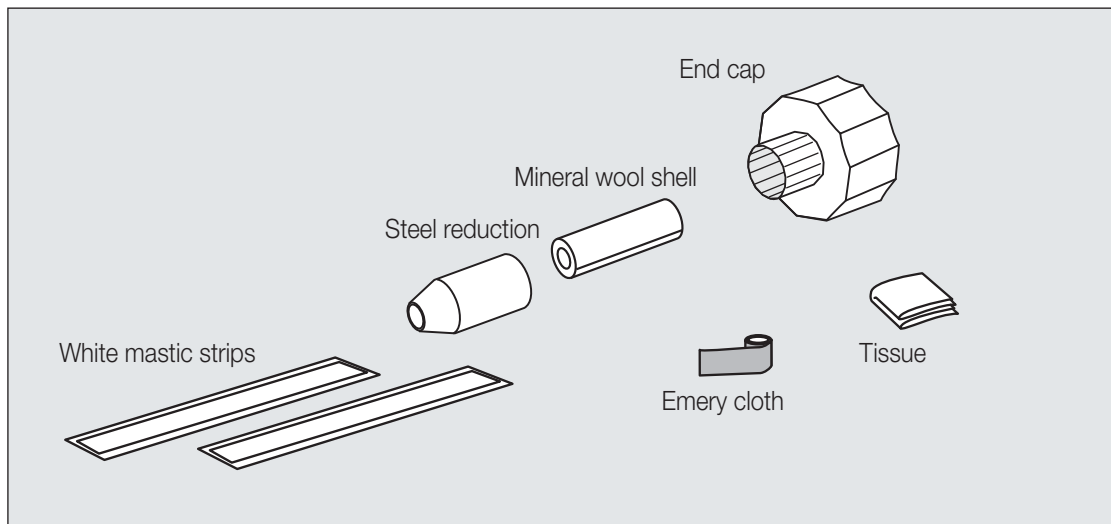



### Important:

Never apply heat to creases, if any, since the material will be discoloured and the surface will crack.

Never apply heat underneath the end cap, as this may damage the end cap permanently.

Pockets of air under the end cap can be removed by bending a piece of welding wire into U-shape and pushing it underneath the end cap while it is still warm.

Use burner head  $\varnothing 51$  mm for end caps up to  $\varnothing 200$  mm. For larger end caps use burner head  $\varnothing 63$  mm.

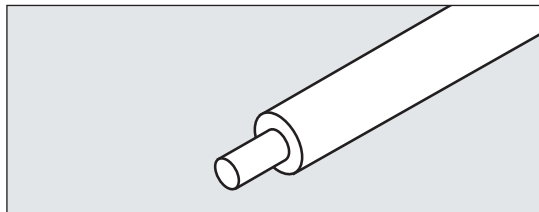

1. Make sure that the pipe end is CLEAN and DRY.

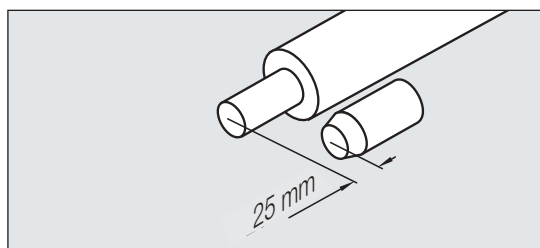

2. Place the steel reduction 25 mm from the steel pipe end.

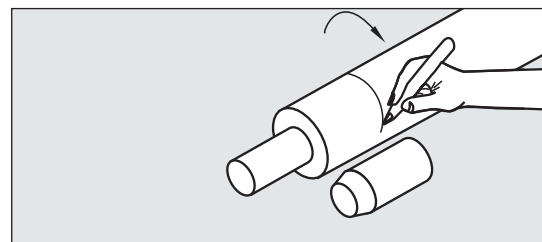

3. Mark the length of the steel reduction on the jacket.

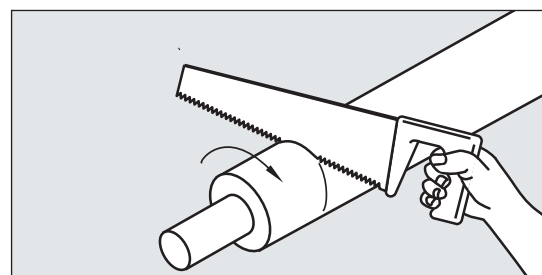

4. Cut the jacket and insulation using the marks as a guide.

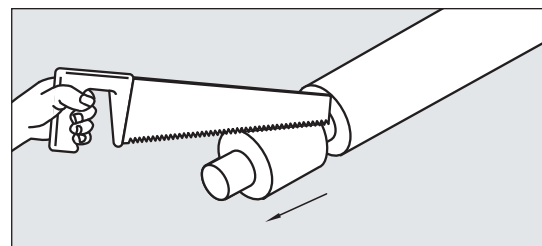

5. Cut lengthwise through the jacket.

# HEC

## High temperature end cap, white, single sealed

### Installation instructions

2/3

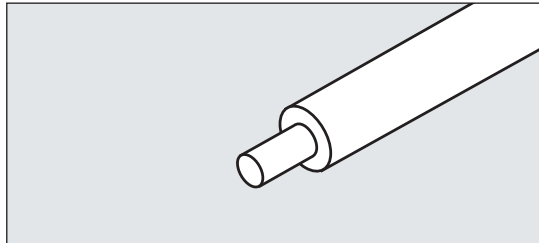

6. Remove jacket and insulation material.

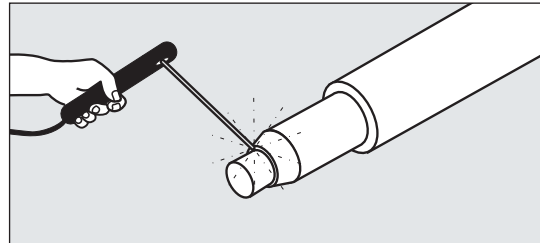

10. Weld the steel reduction to the carrier pipe.

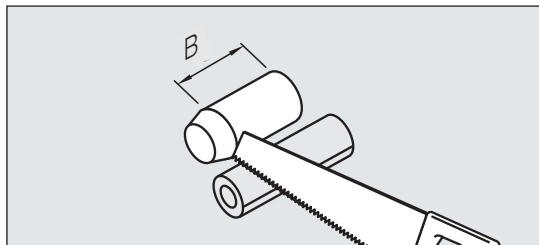

7. Adjust the mineral wool shell to the length of the steel reduction (B).

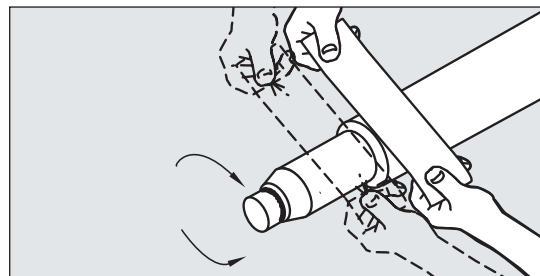

11. Activate the jacket pipe and steel reduction with emery cloth at least 60 mm from the end of the jacket pipe.

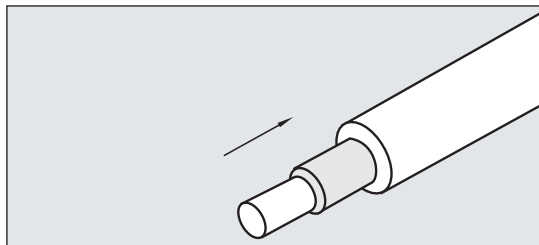

8. Place the mineral wool shell on the carrier pipe as close to the PUR insulation as possible.

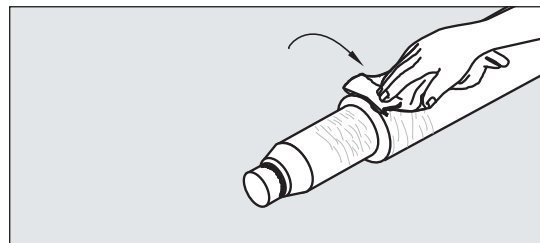

12. Clean the steel reduction and the jacket at least 75 mm from the pipe end. The surface must be **CLEAN** and **DRY**.

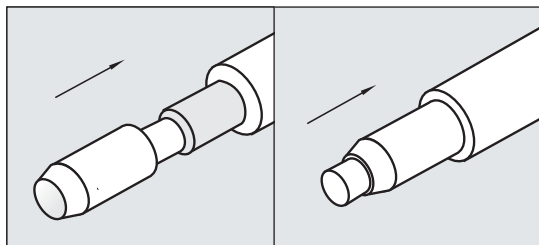

9. Pull the steel reduction onto the carrier pipe and mineral wool shell. The steel reduction is placed correctly when it is in contact with the PUR insulation.

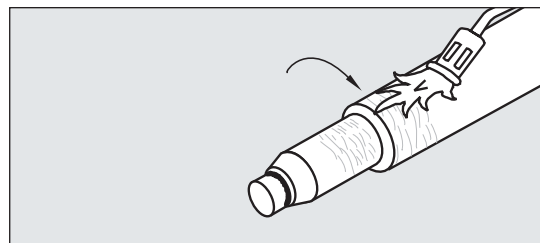

13. Activate the jacket and the steel reduction with the flame at least 60 mm from the end of the jacket pipe until the jacket surface has a matt, silky look.

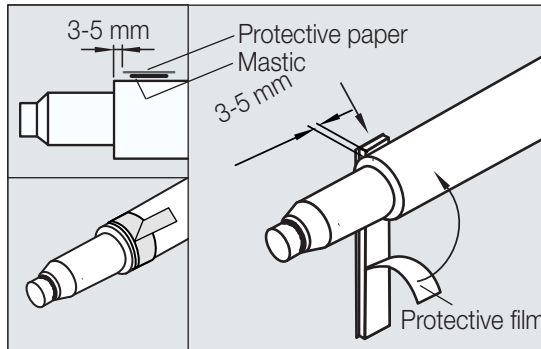

14. Remove the protective film from one of the mastic strips and place the adhesive side face down on the jacket approx. 3-5 mm from the end of the jacket pipe. Make a loop with the protective paper.

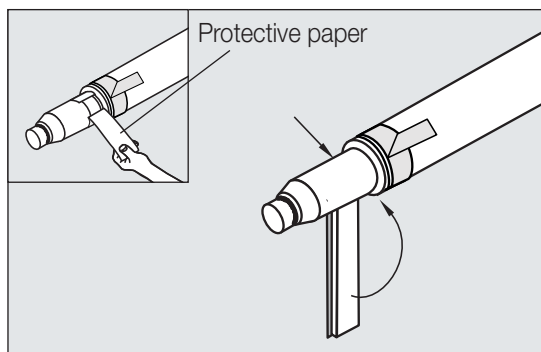

15. Remove the protective film from the second mastic strip and place the adhesive side face down on the steel pipe as close to the insulation as possible. Remove the protective paper.

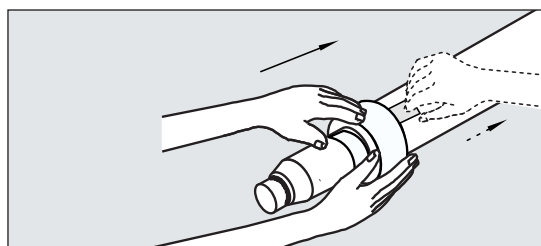

16. Remove the packing from the end cap. Check that it is CLEAN and DRY, inside and out. Pull the end cap onto the steel pipe and mastic strips. Remove the protective paper from the mastic strip.

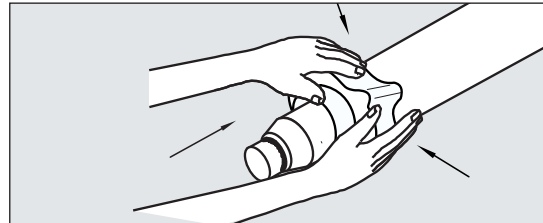

17. The end cap is fastened by pressing the upper part against the mastic strip at 2-3 places.

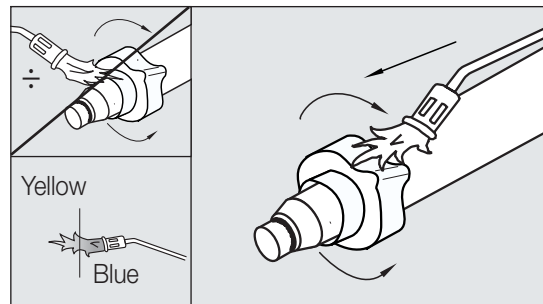

18. Adjust the flame so that the yellow measures approx. 8-10 cm. Start shrinking the end cap onto the jacket. Make sure that heat is not applied directly onto the edge, as the jacket material will be discoloured.

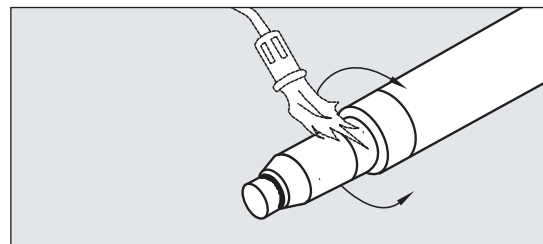

19. After a pause of approx. 1 min. shrink the end cap onto the carrier pipe.

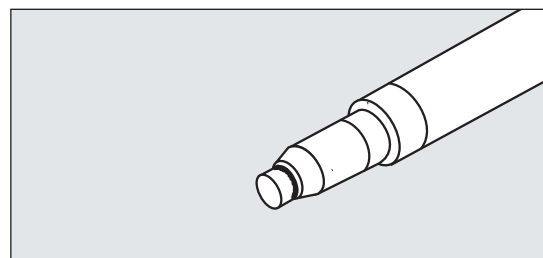

20. The end cap is complete.

---

# Contact details

---

## Denmark

LOGSTOR Denmark Holding ApS  
Danmarksvej 11 | DK-9670 Løgstør

T: +45 99 66 10 00  
E: [logstor@kingspan.com](mailto:logstor@kingspan.com)



For the product offering in other markets please contact your local sales representative or visit [www.logstor.com](http://www.logstor.com)

Care has been taken to ensure that the contents of this publication are accurate, but Kingspan Limited and its subsidiary companies do not accept responsibility for errors or for information that is found to be misleading. Suggestions for, or description of, the end use or application of products or methods of working are for information only and Kingspan Limited and its subsidiaries accept no liability in respect thereof.

To ensure you are viewing the most recent and accurate product information, please scan the QR code directly above.

